

# Stern T-11

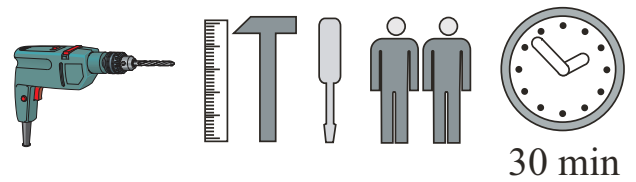
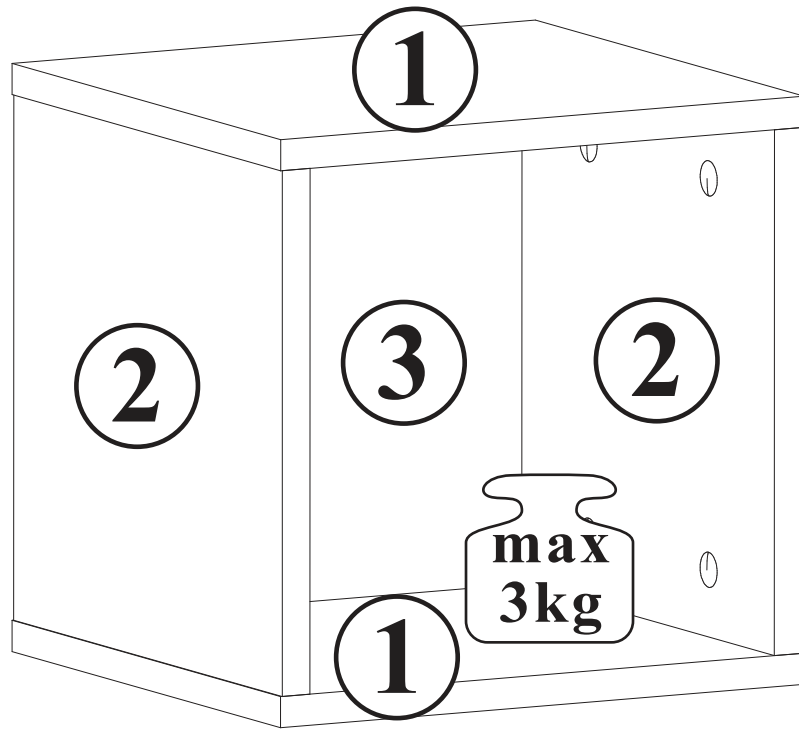
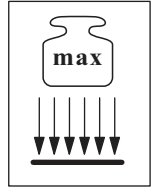

30 min

NO	DIM.			COL-NO	QTY
1	302	286	16	1	2
2	270	286	16	1	2
3	270	269	16	1	1

# Stern T-11

A1 x12 ø8x30	B4 x12	B5 x12 ø15x12	G5 x12	ZM1 x2	D28 x4 EsØ6x13
D10 x2 USØ3,5x16	G2 x1	KR2 x2	P3 x2		

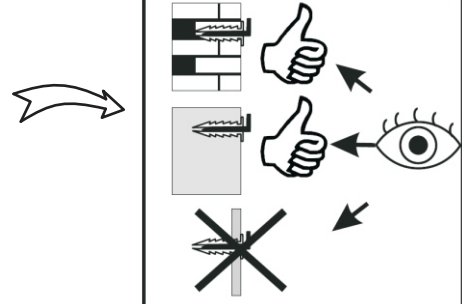
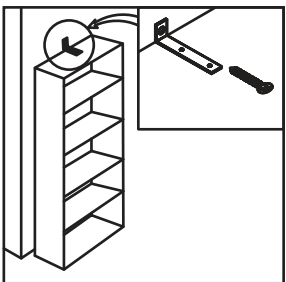
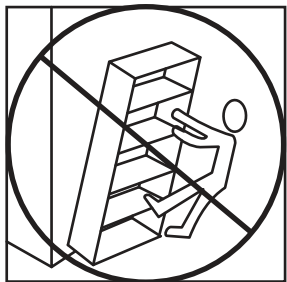
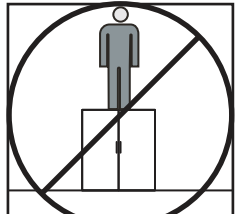
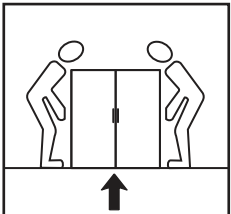
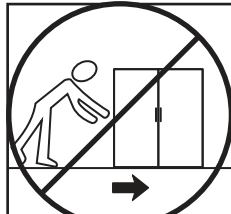
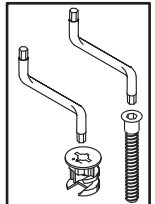
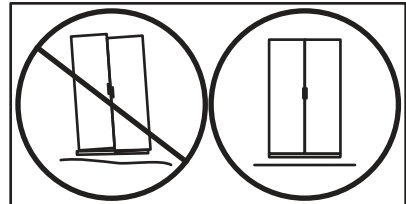
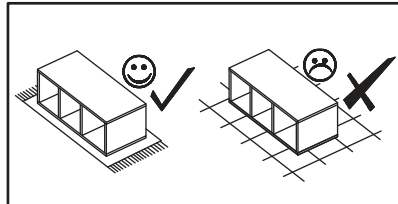
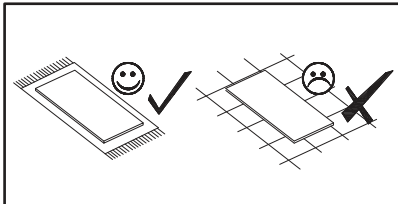
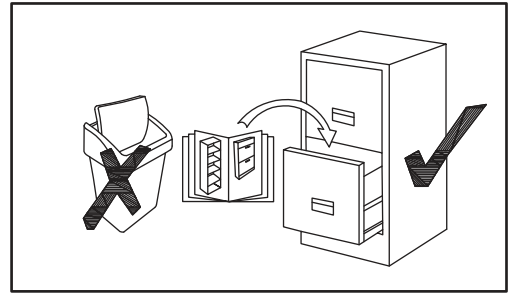
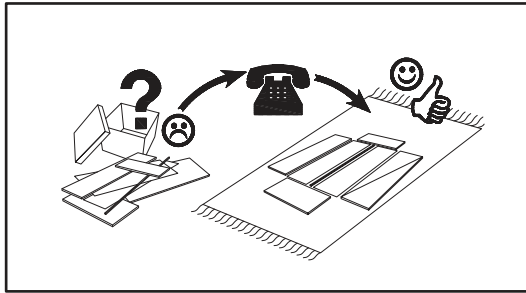
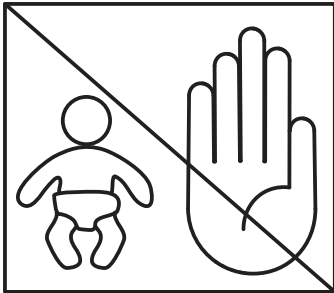
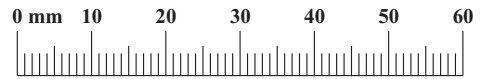

# Stern T-11

1

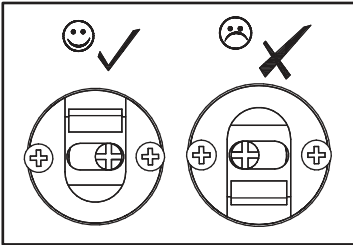
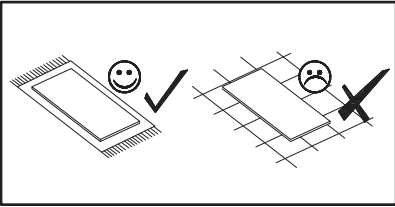

D10		B5		B4	
x2	USØ3,5x16	x12	ø15x12	x12	

ZM1		D28		A1	
x2		x4	EsØ6x13	x12	ø8x30

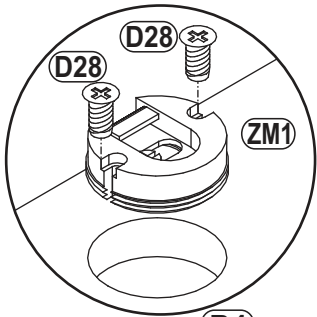
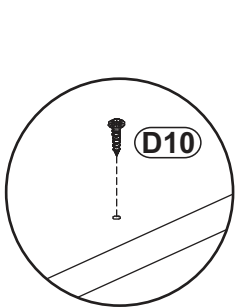

A1

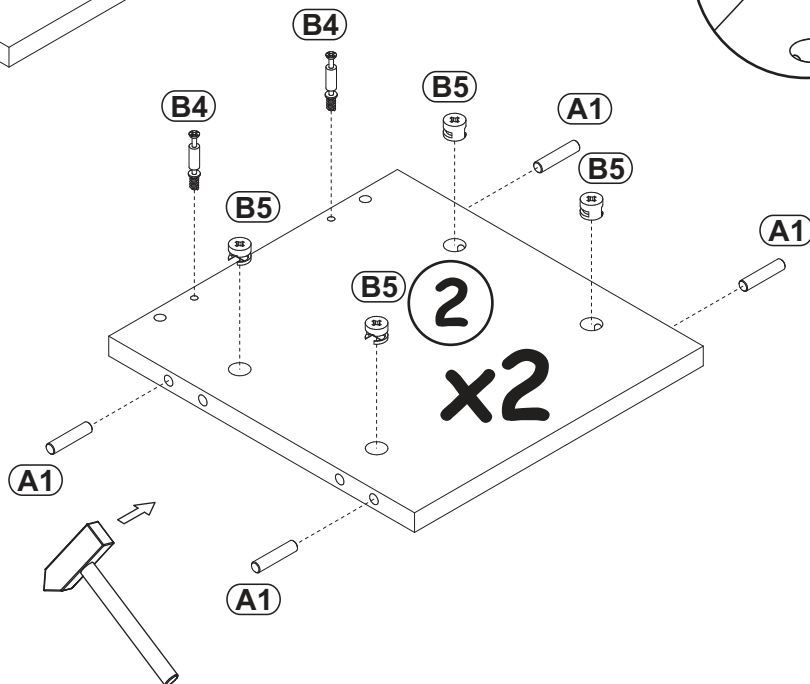
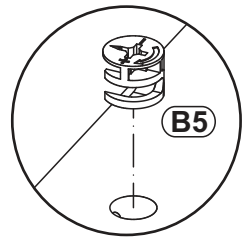
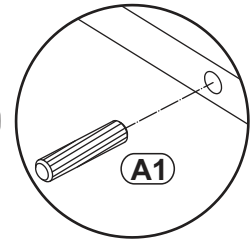
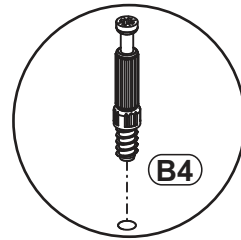
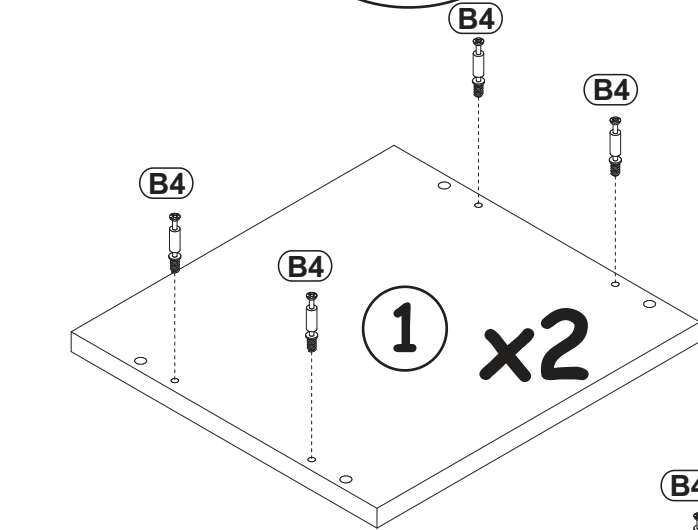
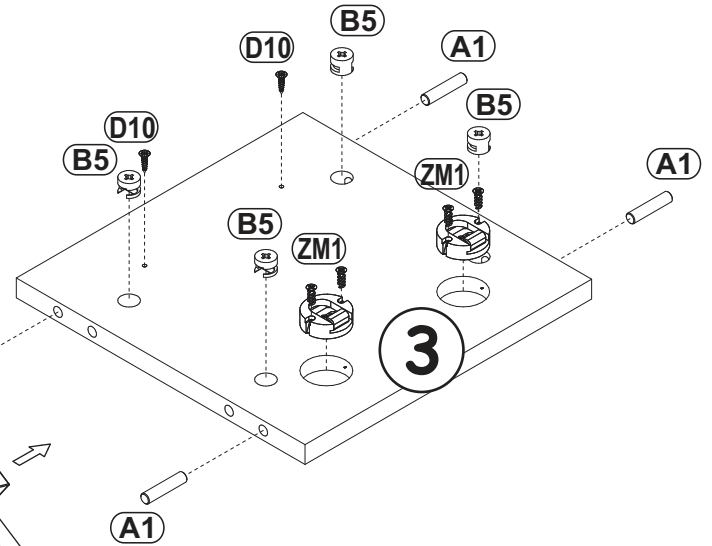

# Stern T-11

G5	
x4	

2

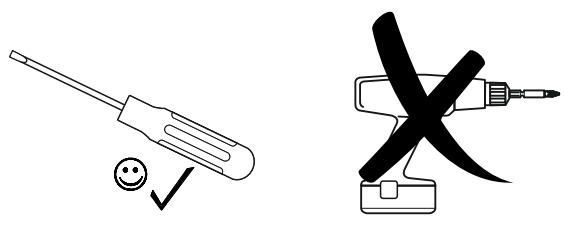
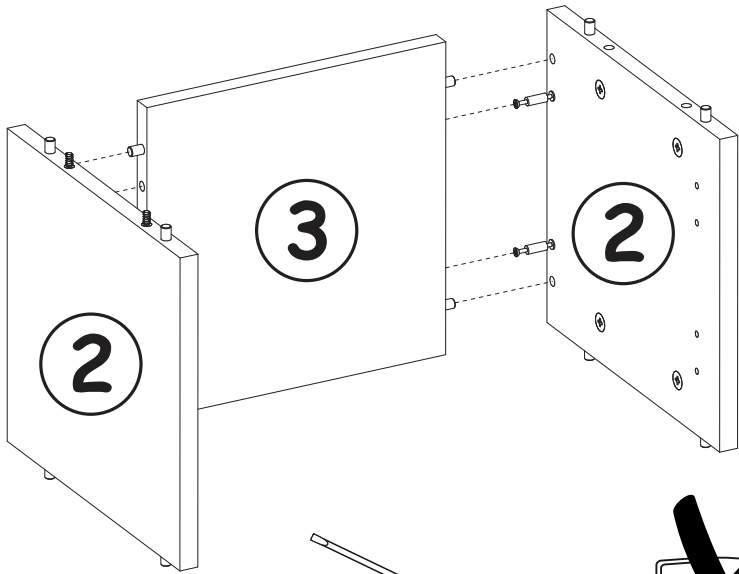
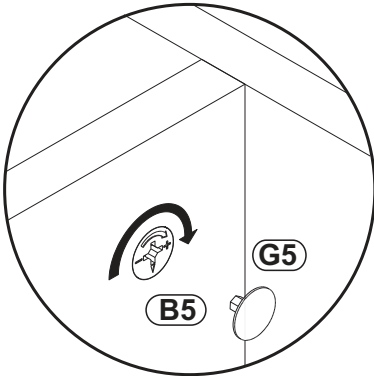
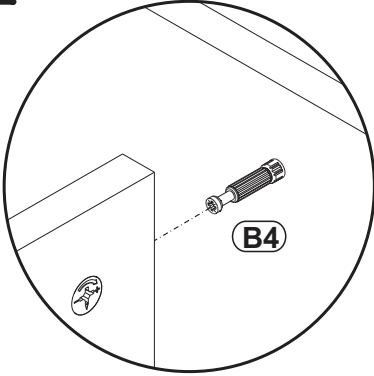

3

G5	
x8	

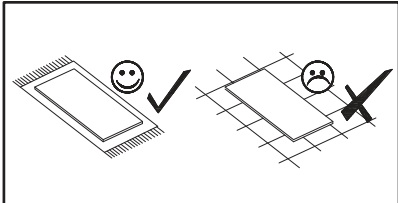
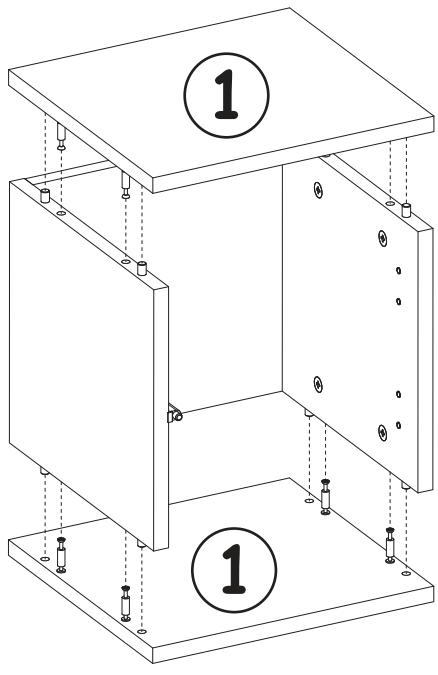
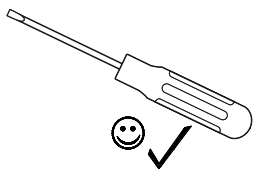
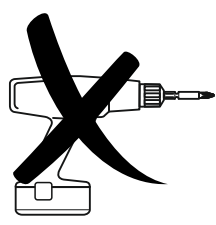
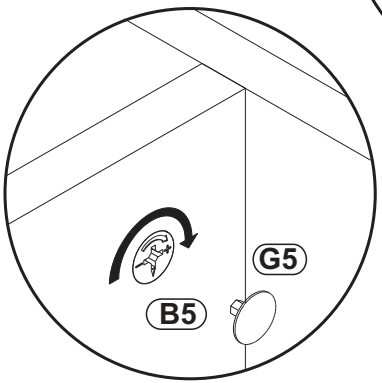
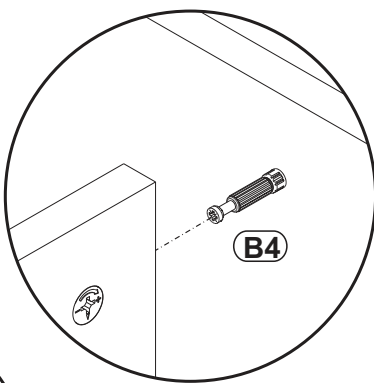

# Stern T-11

4

