

Teknik Ölçüler / Technical Dimensions

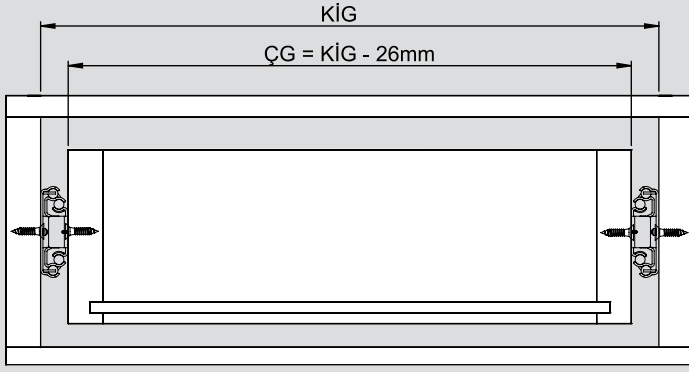

Parçalar / Parts

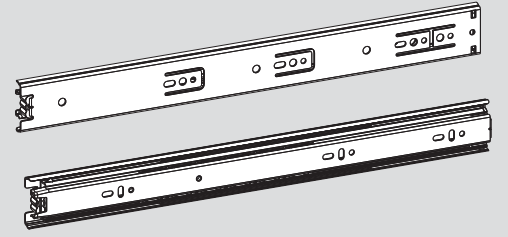

Tavsiye Edilen Vida / Recommended Screw



Kabin Ölçüleri / Cabinet Dimensions

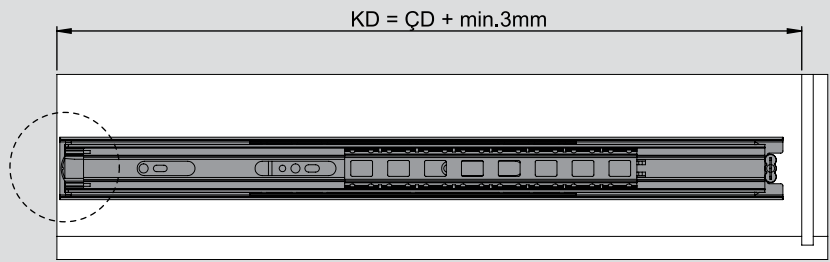
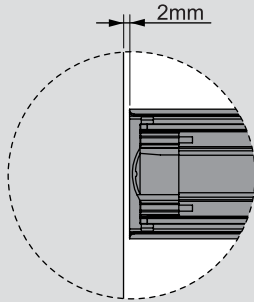

Çekmece Ölçüleri / Drawer Dimensions

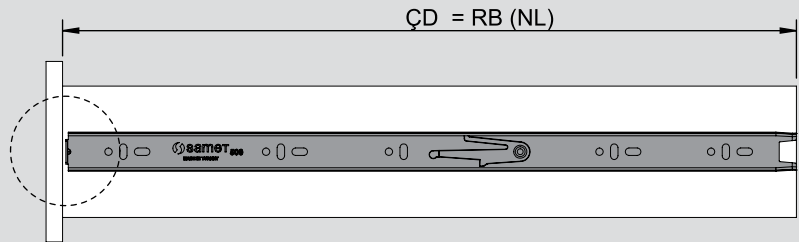
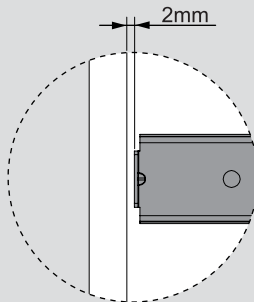

KİG : Kabin İç Genişliği / Cabinet Inner Width
ÇG : Çekmece Genişliği / Drawer Width

KD : Kabin Derinliği / Cabinet Depth
ÇD : Çekmece Derinliği / Drawer Depth

RB : Ray Uzunluğu / Nominal Length

Montaj / Assembly

1

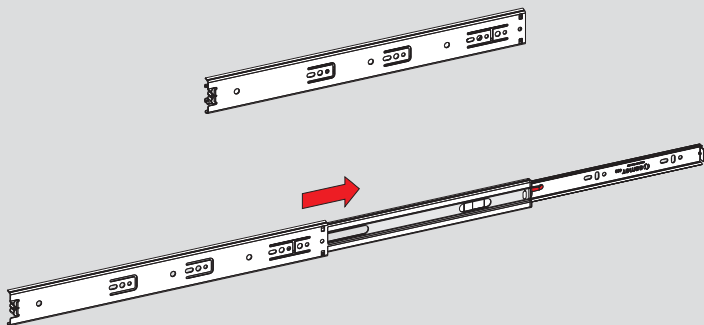

2

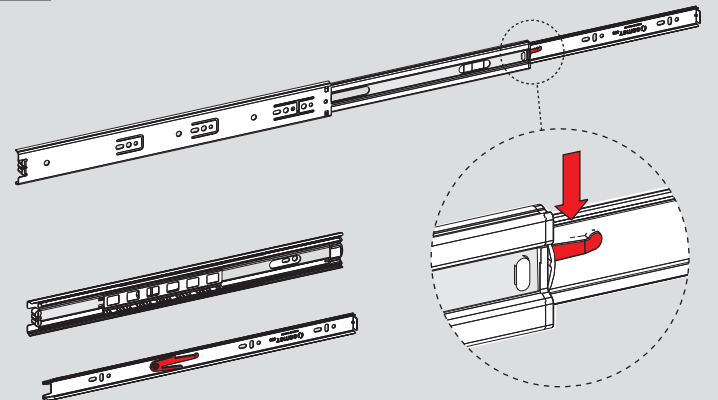

3

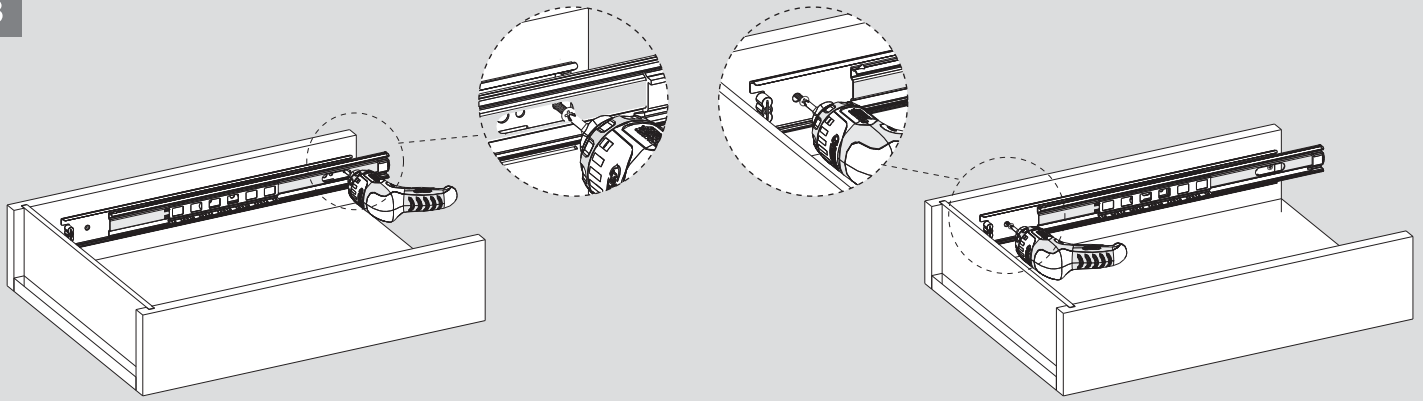

4

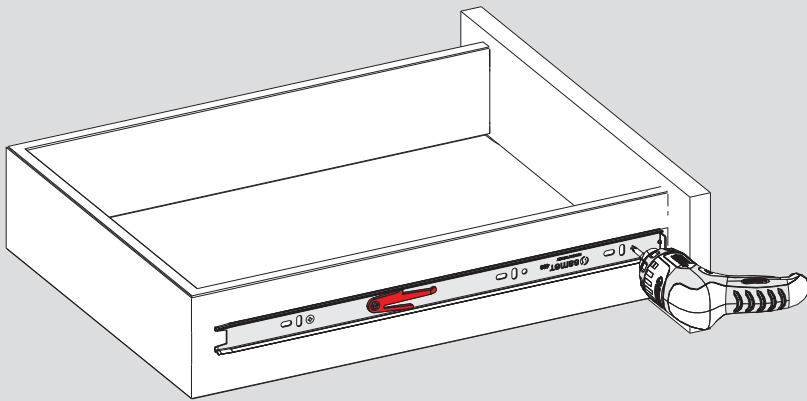

5

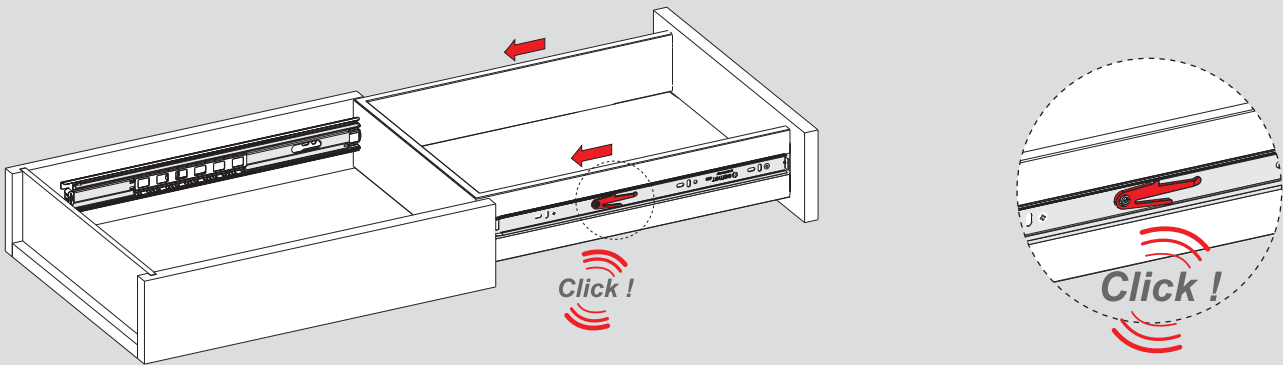

7

